

Block Diagram of PDA (0.0 edit 103 v_10)

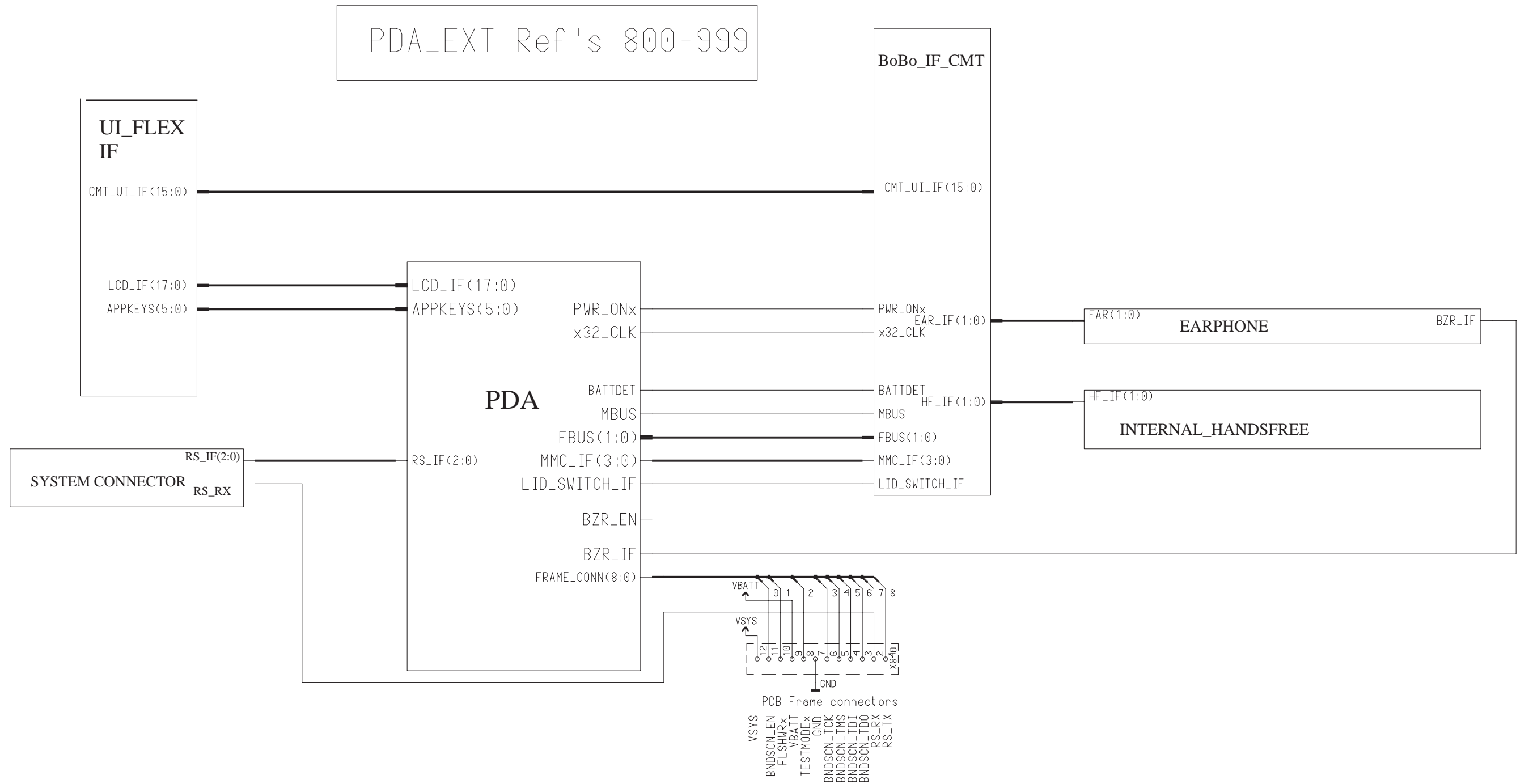

PDA_EXT Ref 's 800-999

PDA Ref 's 300-450

PDA_PWRU Ref 's 450-499

Circuit Diagram of UI FLEX IF (0.0 Edit 72) for ver_10

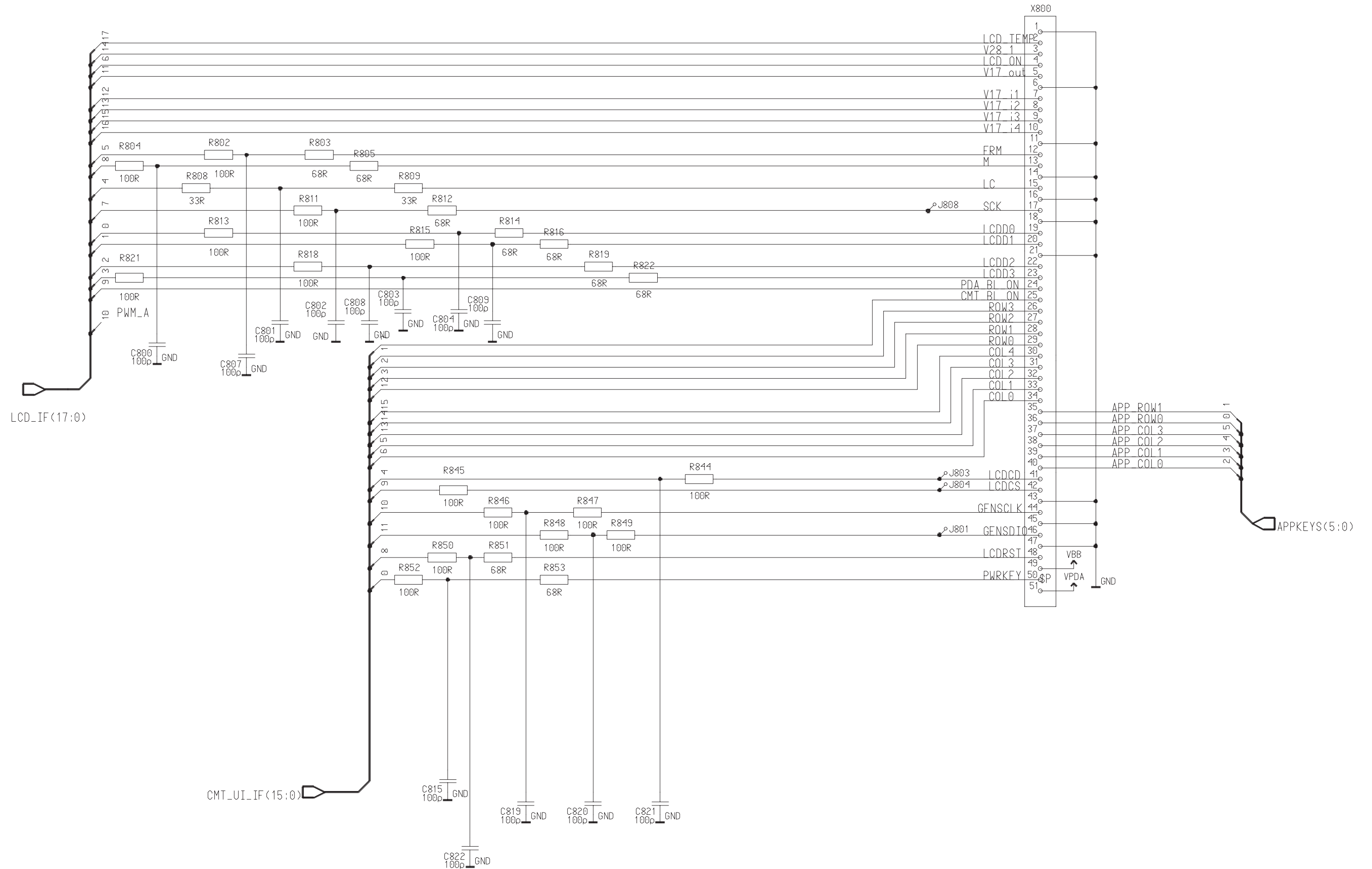

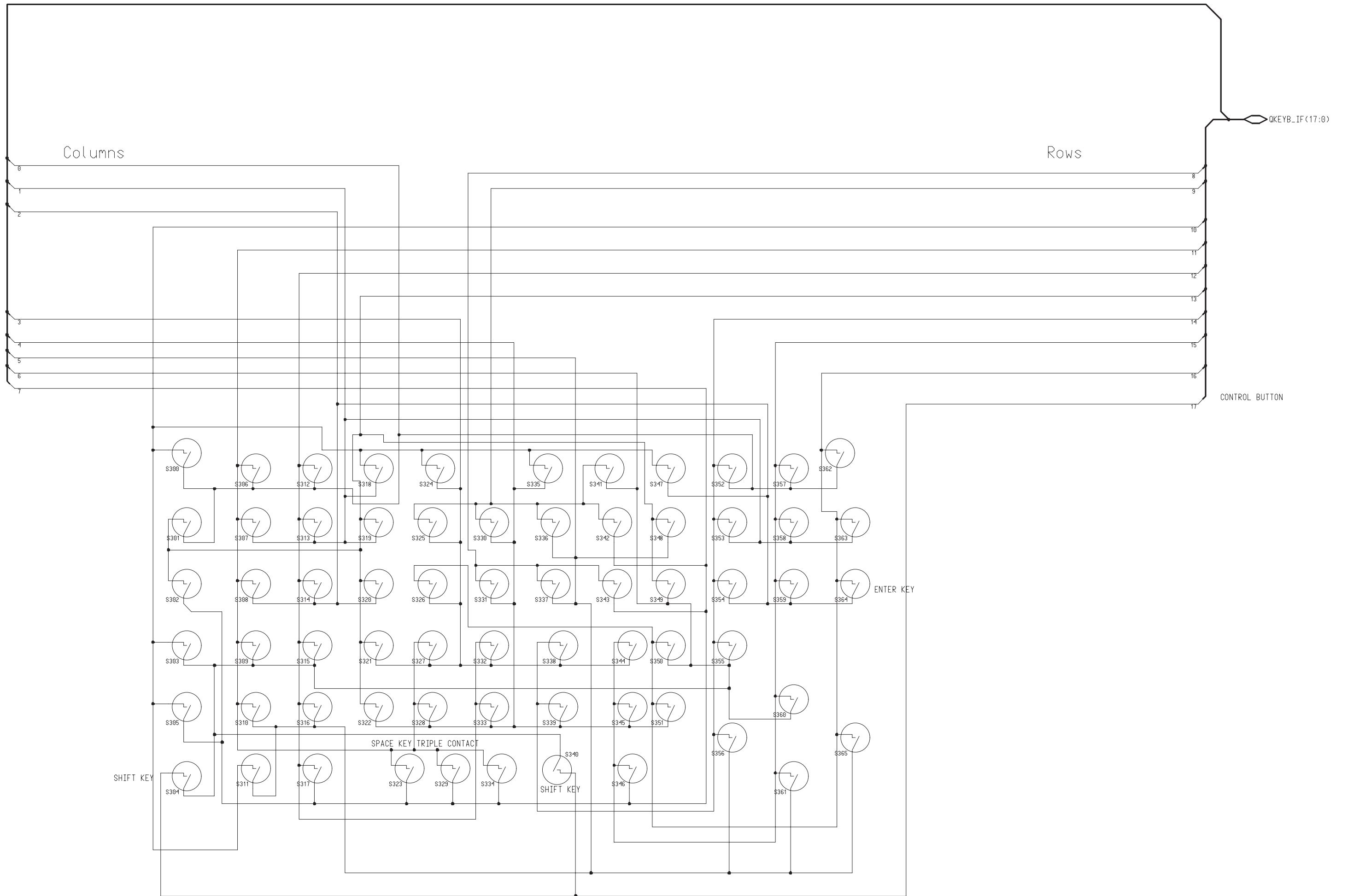

Circuit Diagram of BS1 PDA PWRU (0.0 Edit 137) for ver_10

REFS 450-499

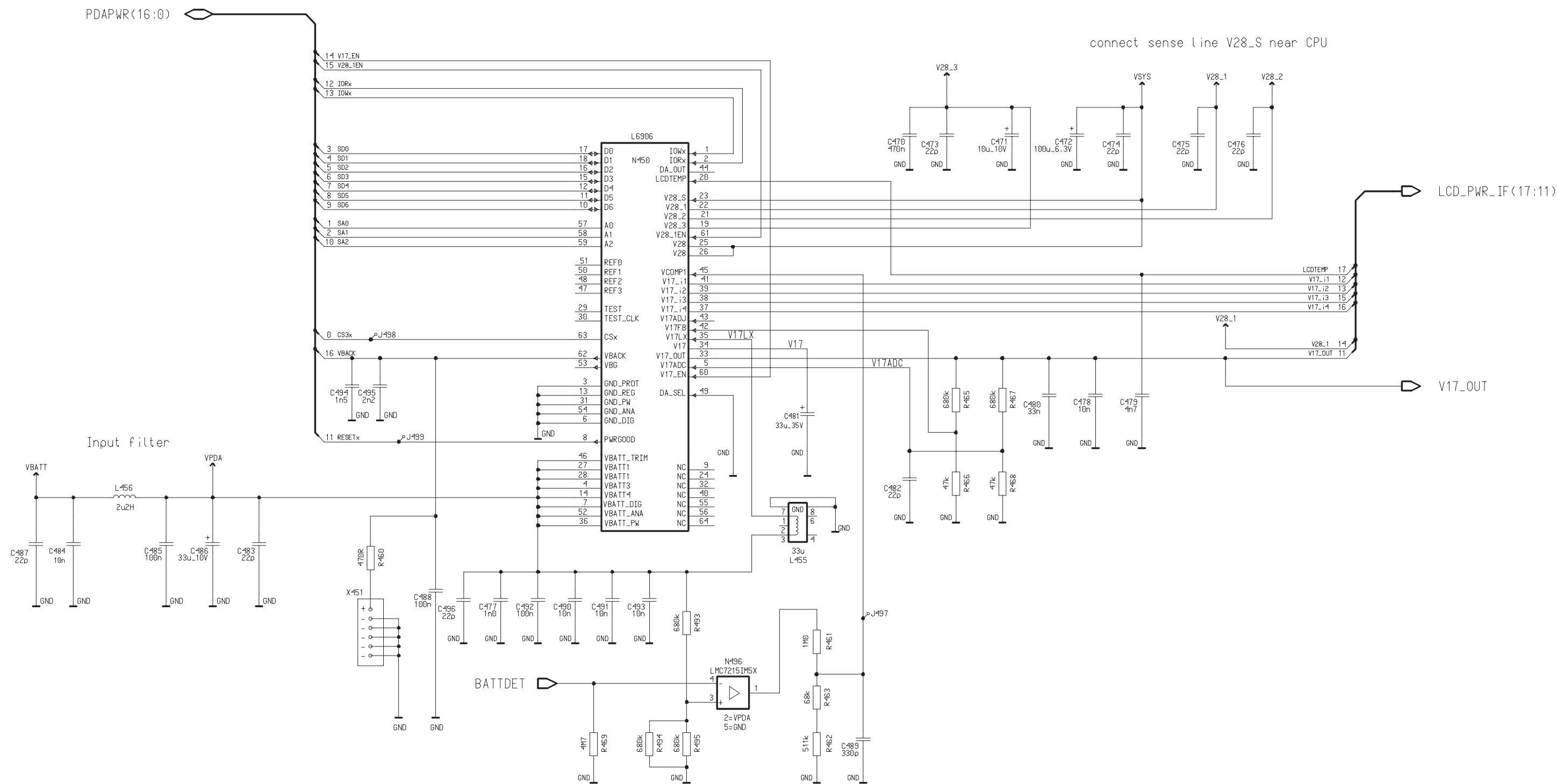

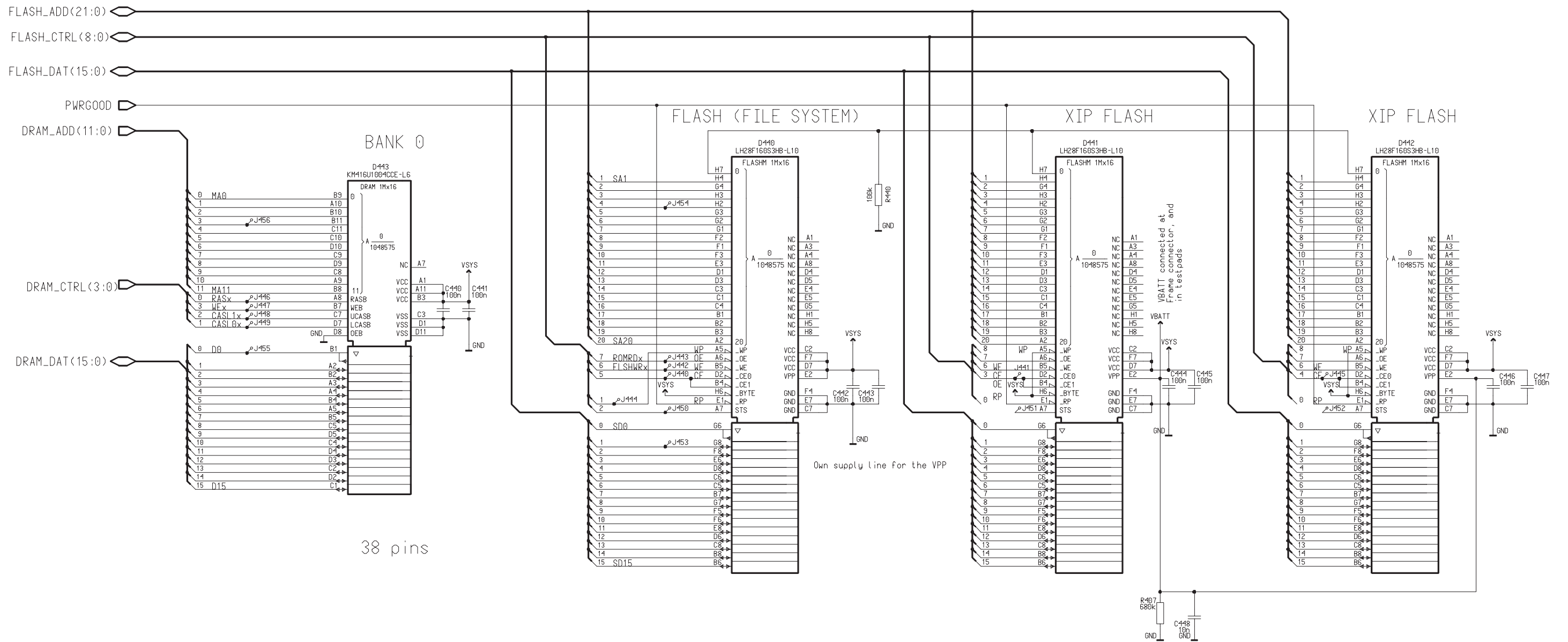

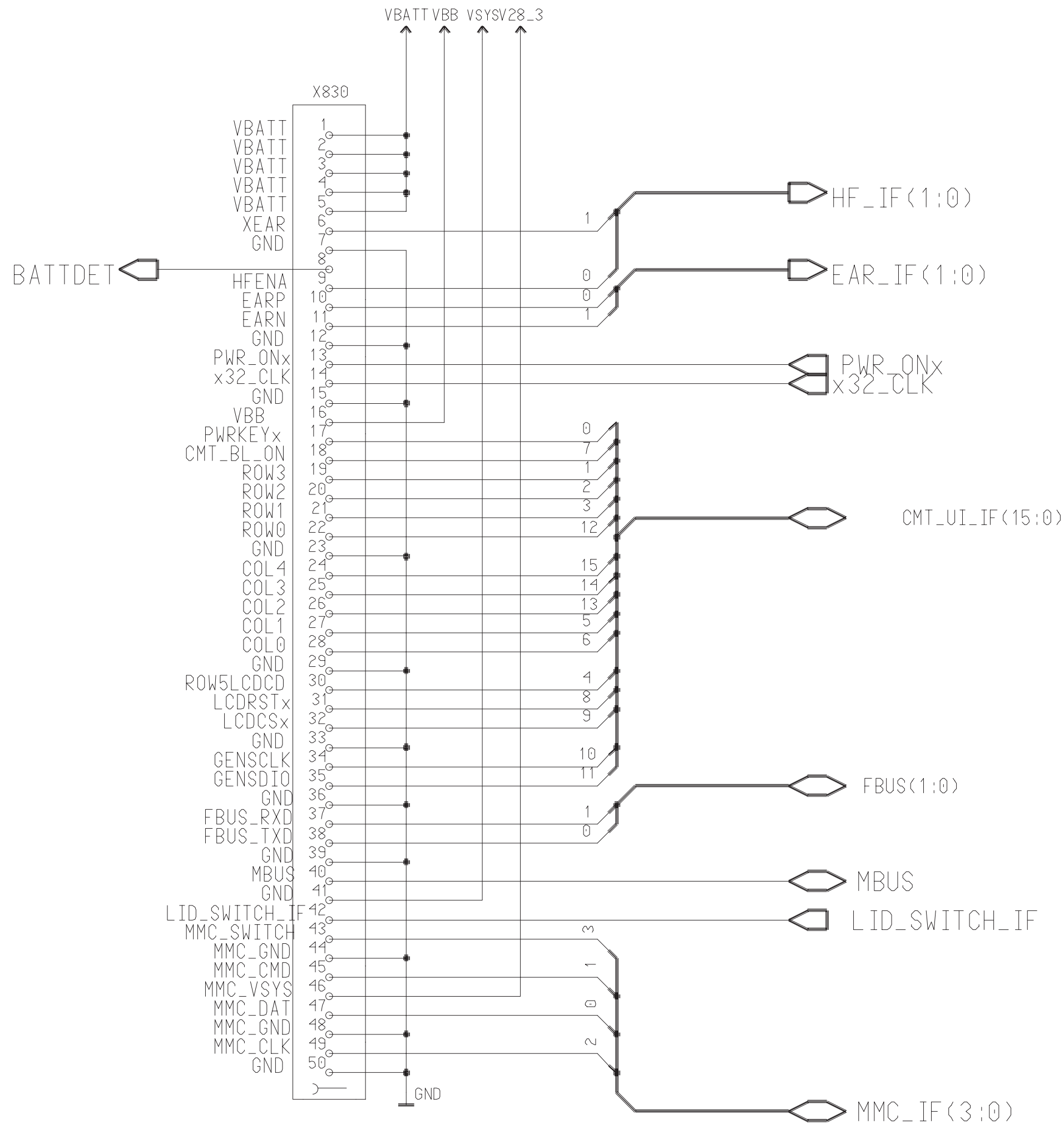

Circuit Diagram of BS1 PDA Internal HF IF (0.0 Edit 83) for ver_10

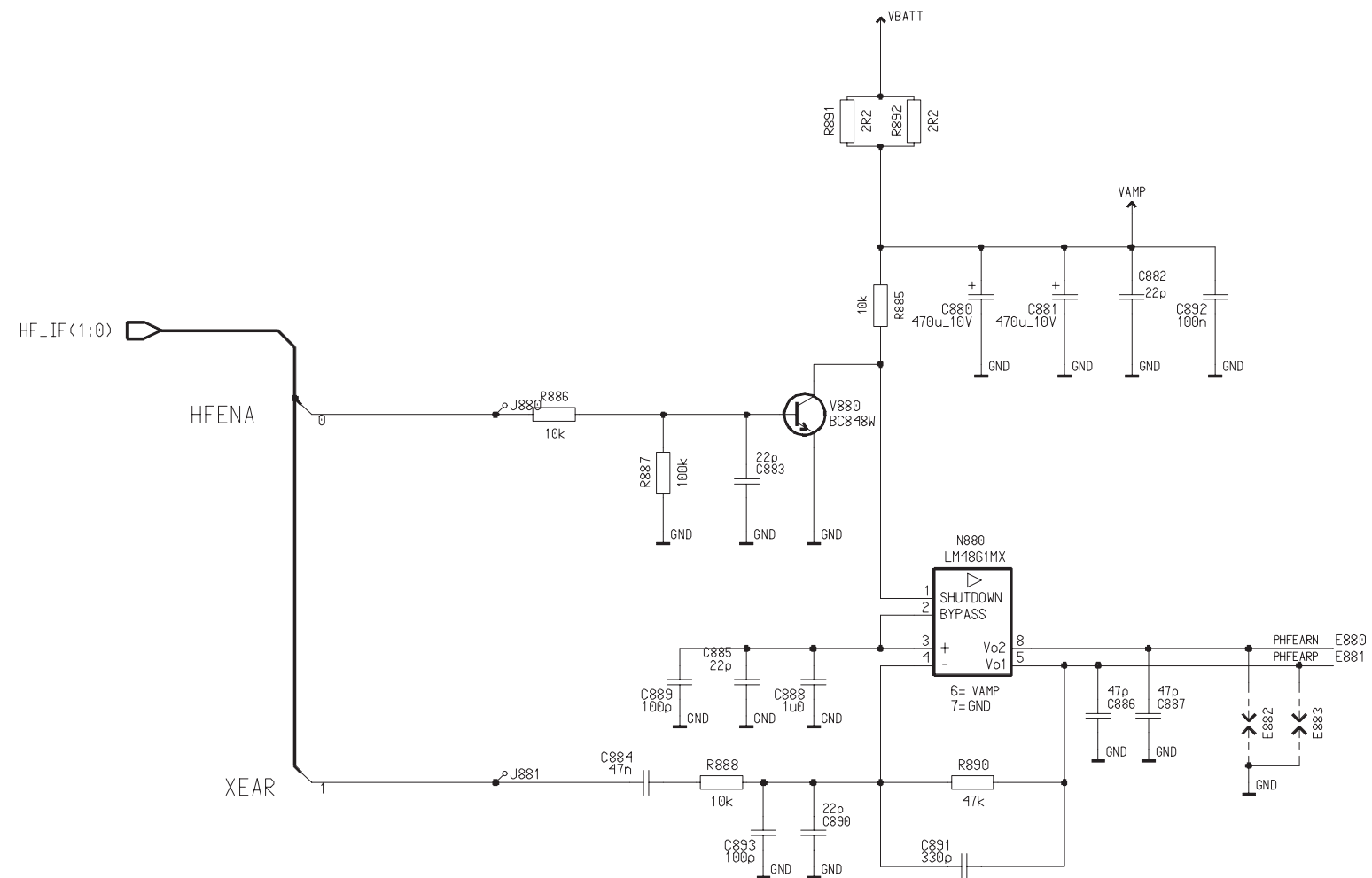

Circuit Diagram of BS1 PDA Earphone (0.0 Edit 25) for ver_10

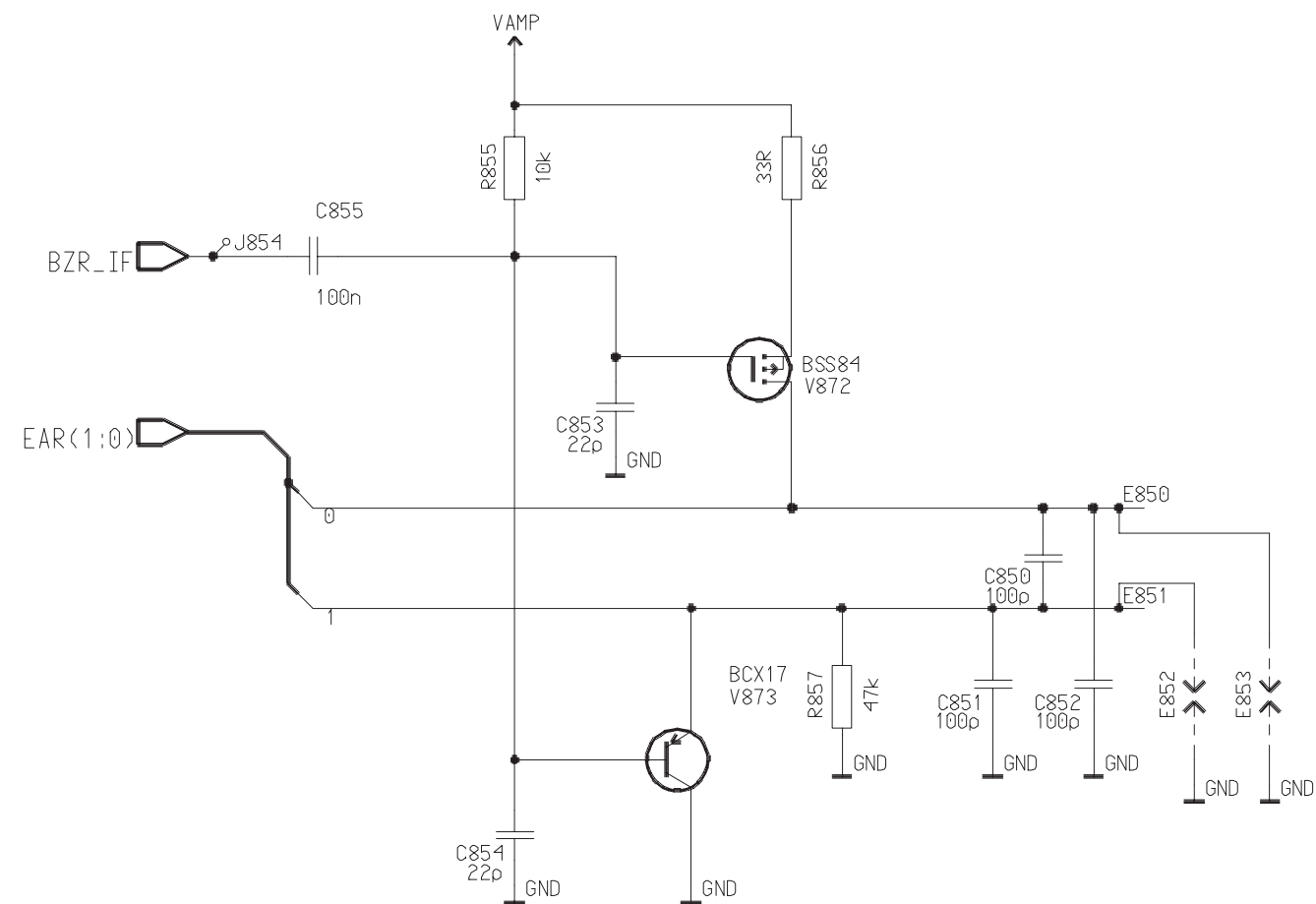

Circuit Diagram of BS1 PDA PLL (0.0 Edit 42) for ver_10

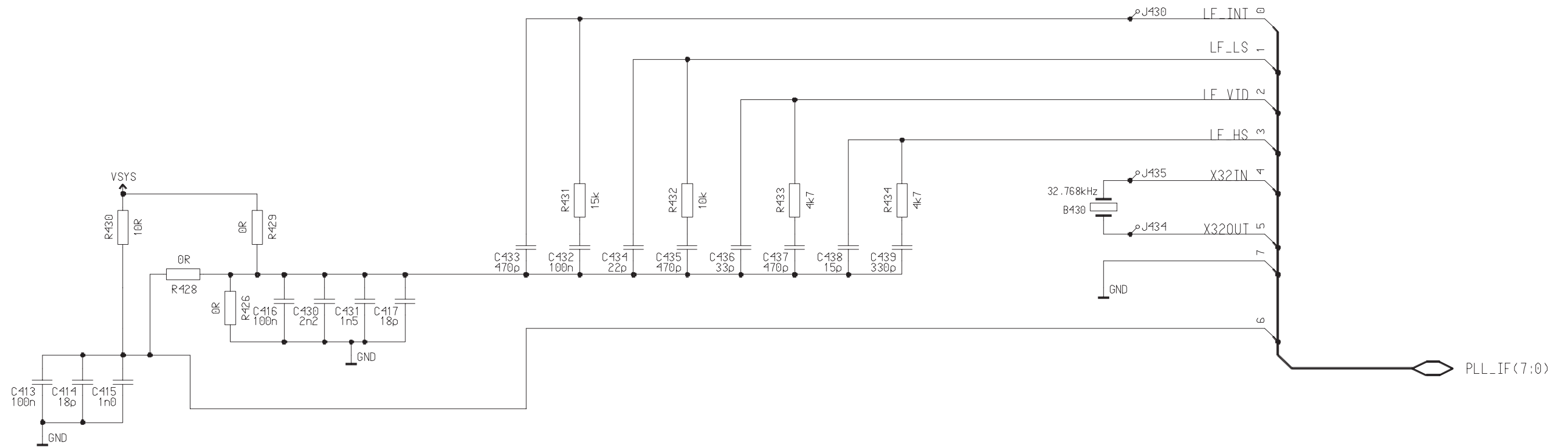

Circuit Diagram of BS1 PDA IRDA (0.0 Edit 27) for ver_10

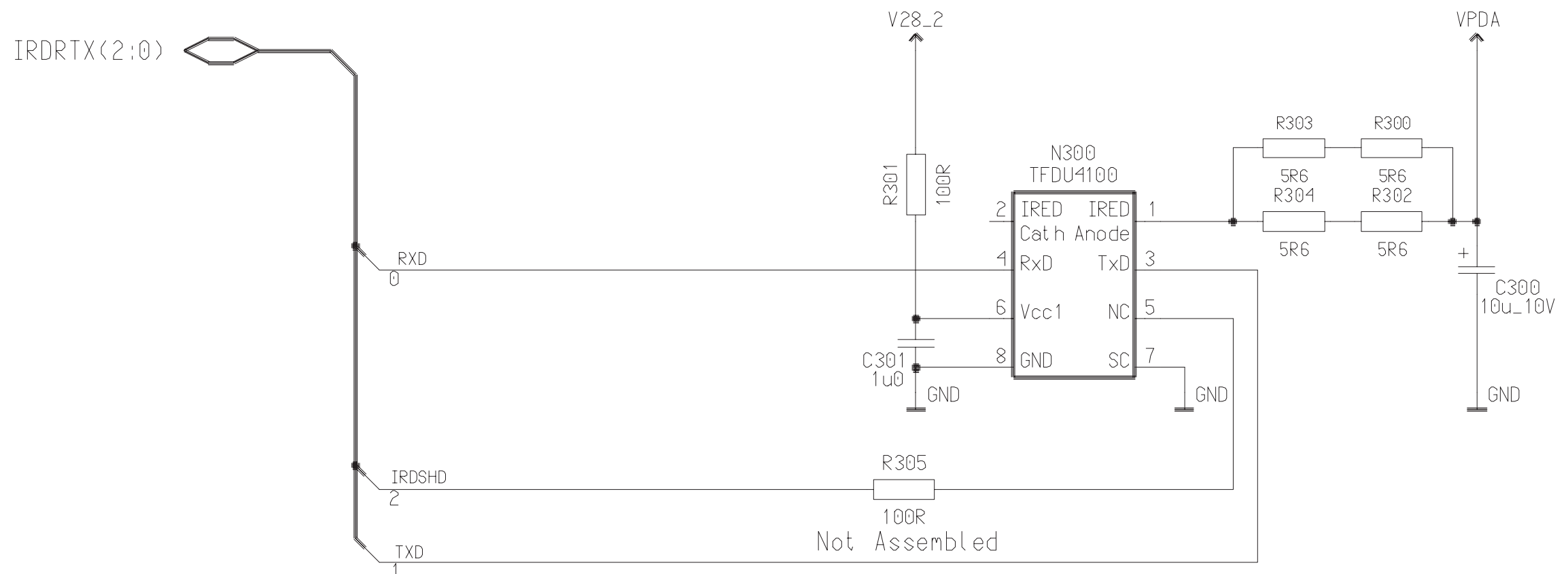

Circuit Diagram of BS1 System Connector Pads (0.0 Edit 26) for ver_10

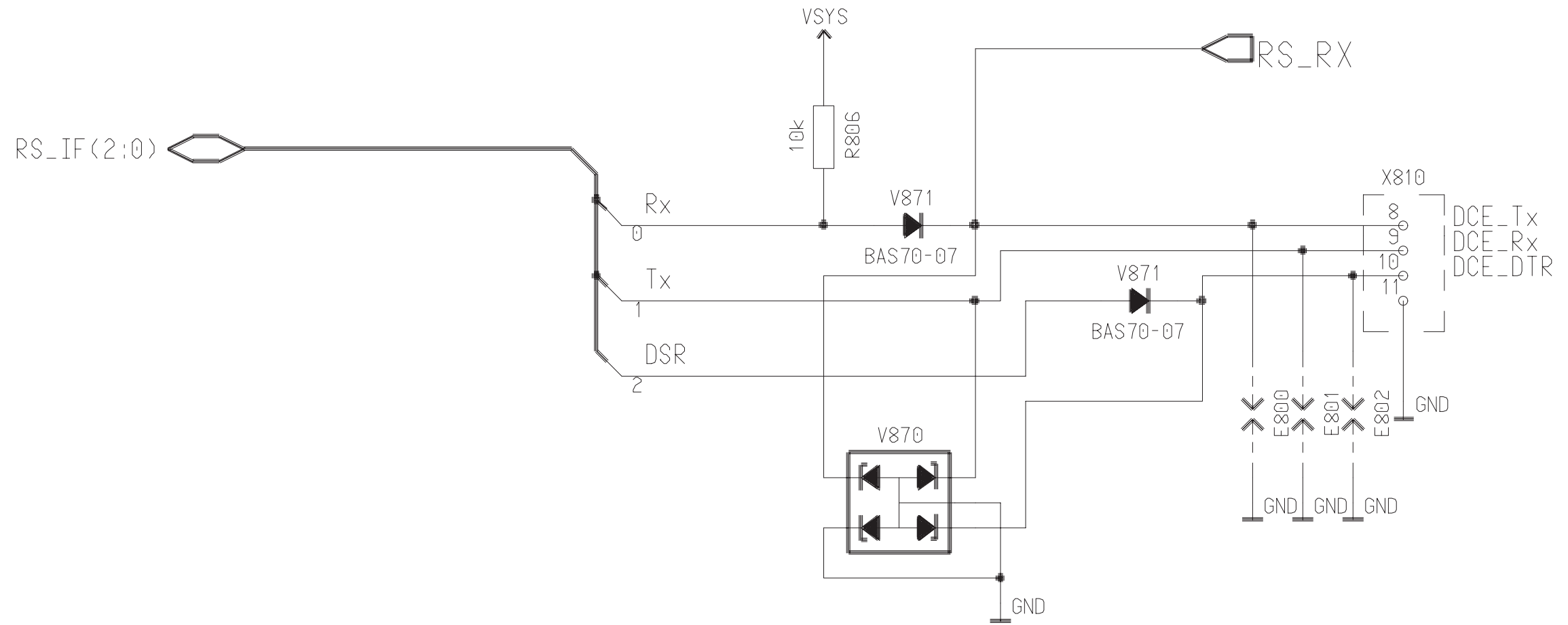

Circuit Diagram of BS1 Lid Switch (0.0 Edit 26) for ver_10

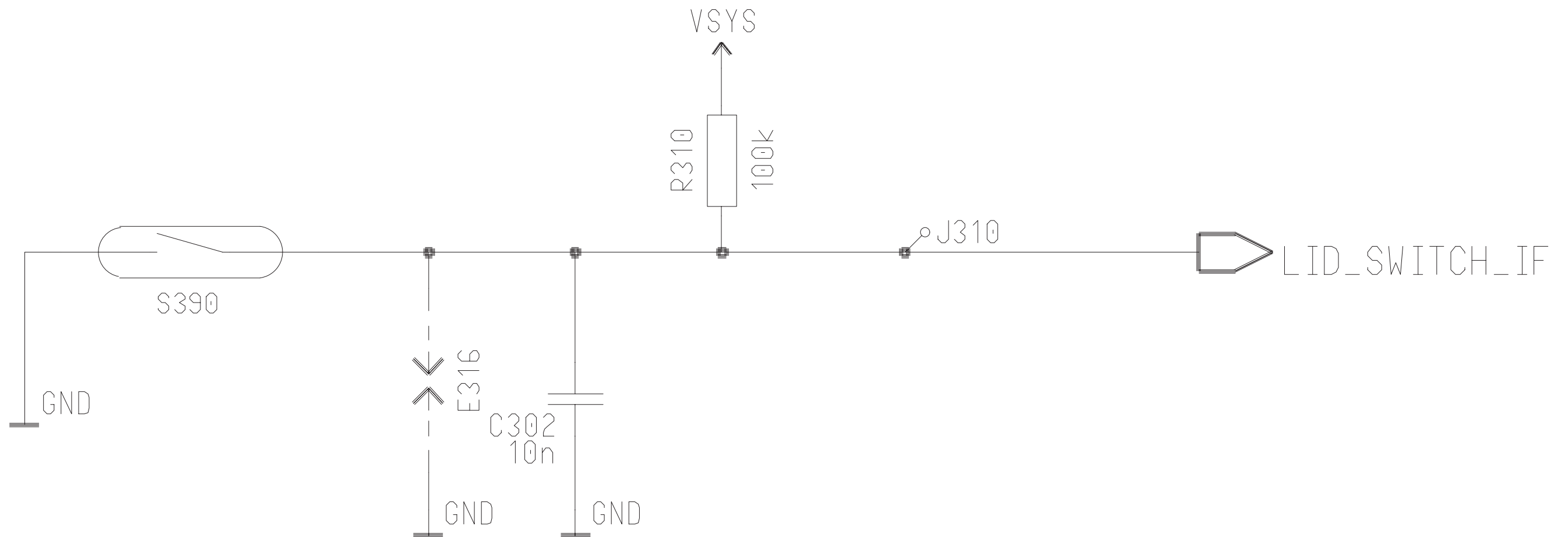

FBUSTX Line Should from BB to TESTPADS and connectd to FBUSTX2 and route to SCOTTY.
 FBUSRx Line Must also routed trough testpads so that both Rx and Tx Lines goes same route and have almost same length !

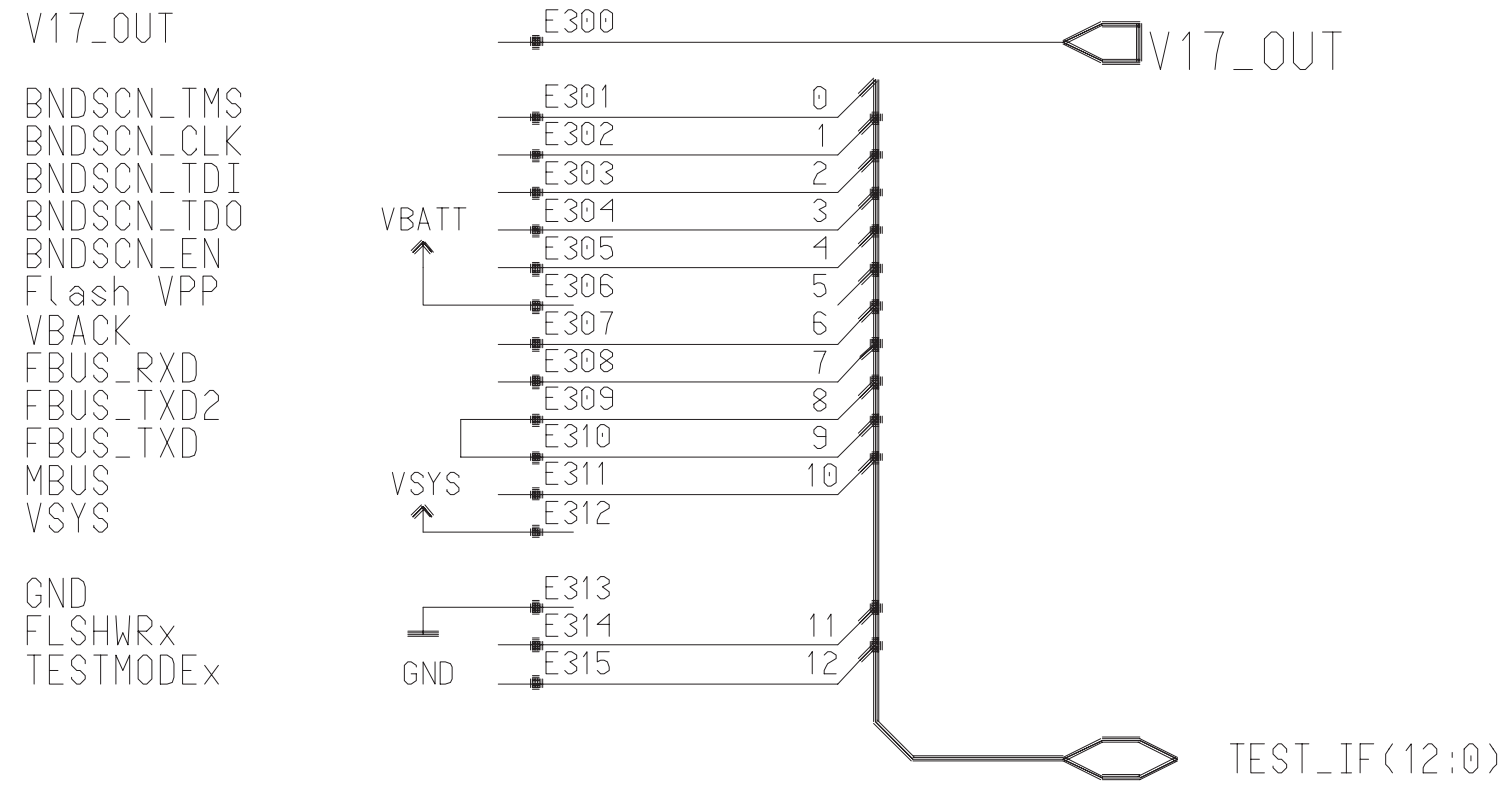

VBATT should connect together with XIP Flash VPP Which is separately routed from frame connector

Parts Placement Diagram of BS1 PDA 1/2 (0.0) _10

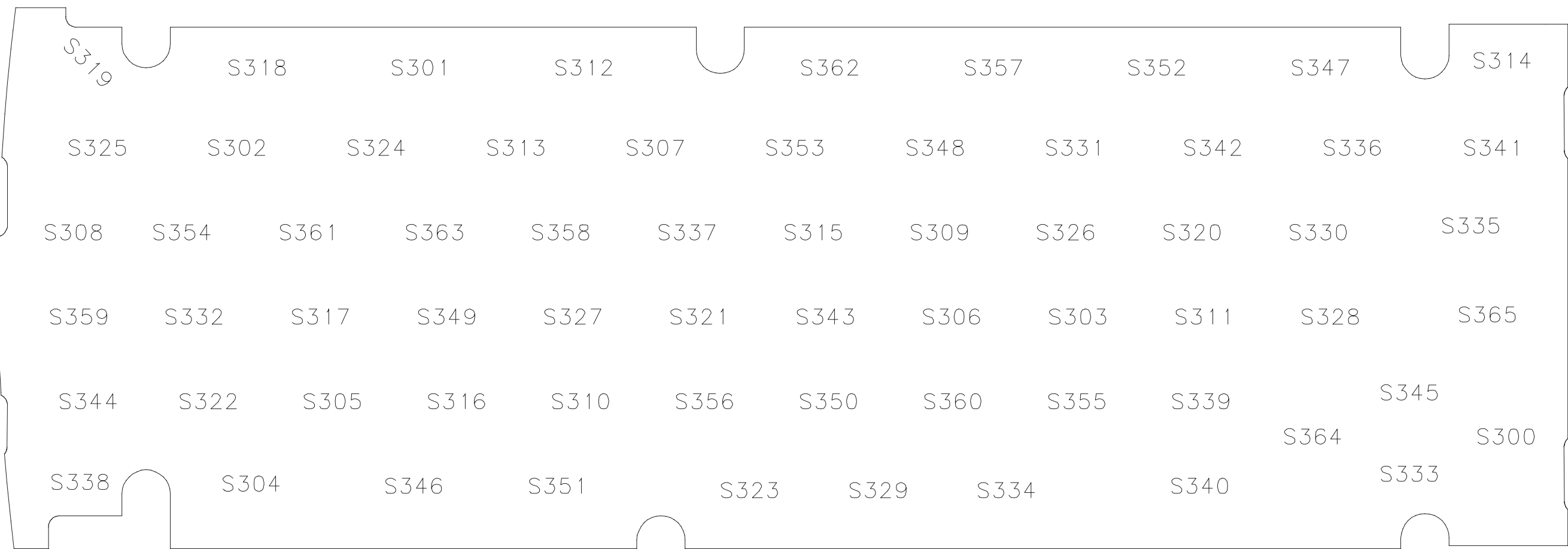

Parts Placement Diagram of BS1 PDA 2/2 (0.0) _10

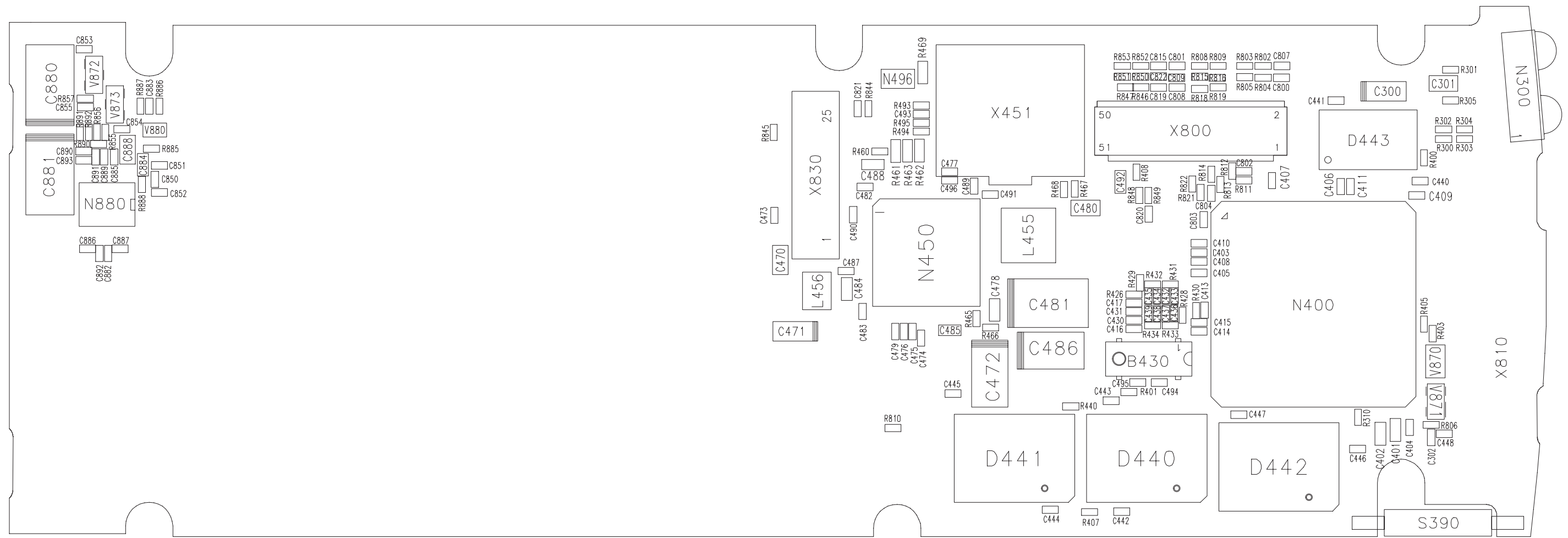

Circuit Diagram of BS2 (0.0 Edit 116) _09

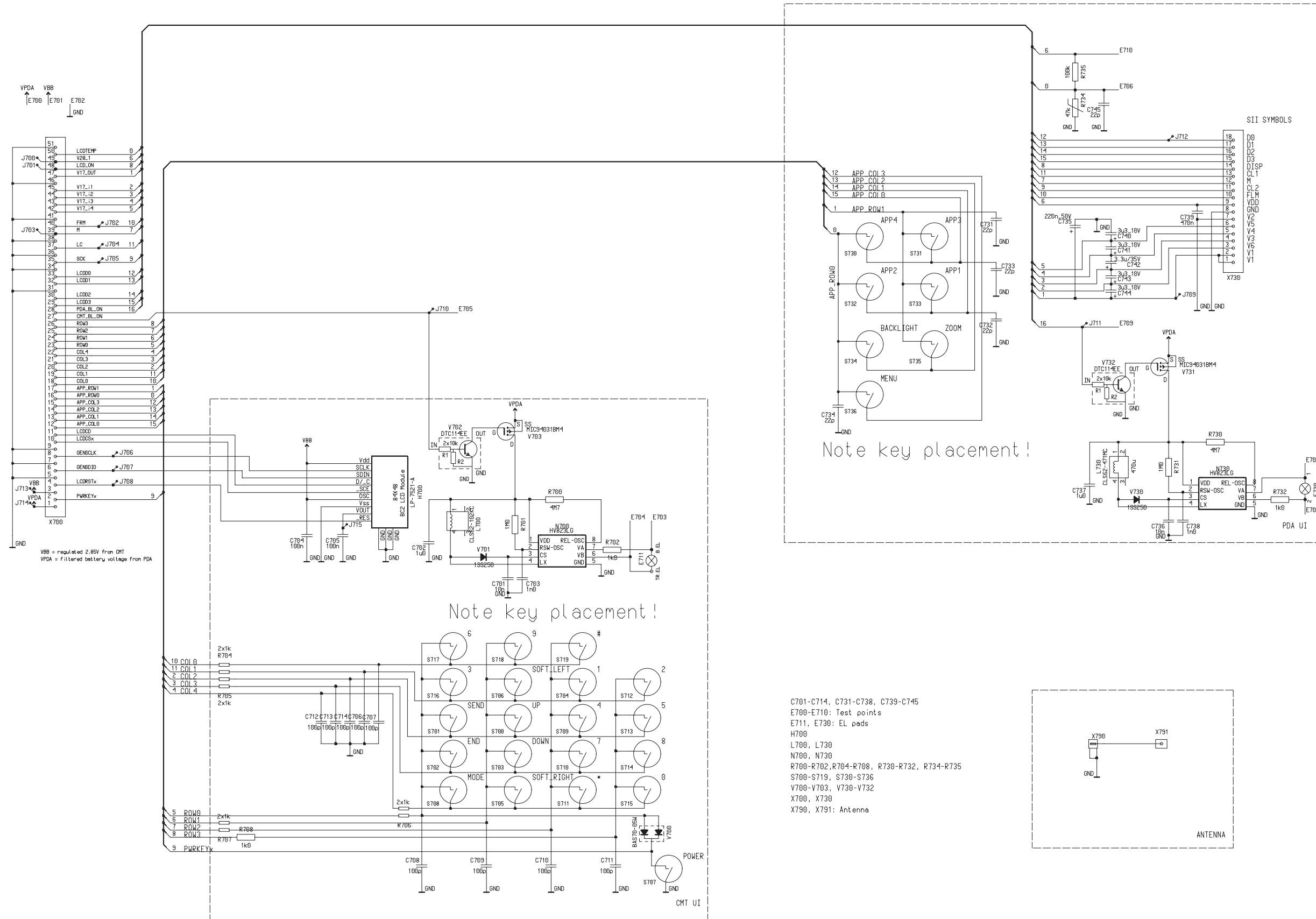

Note key placement!

Note key placement!

- C701-C714, C731-C738, C739-C745
- E700-E710: Test points
- E711, E730: EL pads
- H700
- L700, L730
- N700, N730
- R700-R702, R704-R708, R730-R732, R734-R735
- S700-S719, S730-S736
- V700-V703, V730-V732
- X700, X730
- X790, X791: Antenna

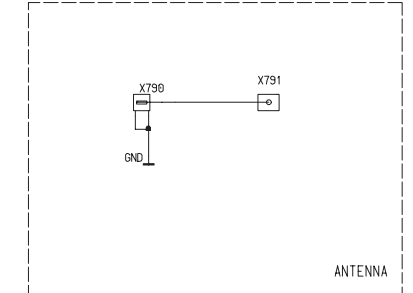

Parts Placement Diagram of BS2 1/2) _09

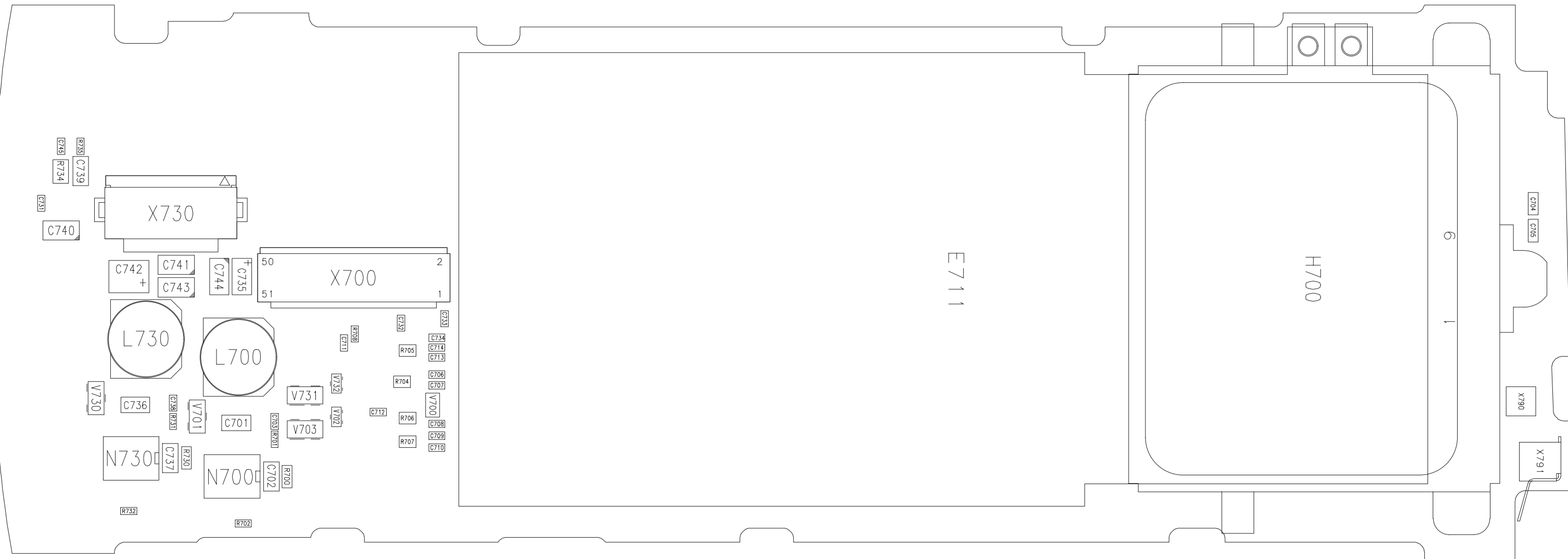

Parts Placement Diagram of BS2 2/2 (0.0) _09

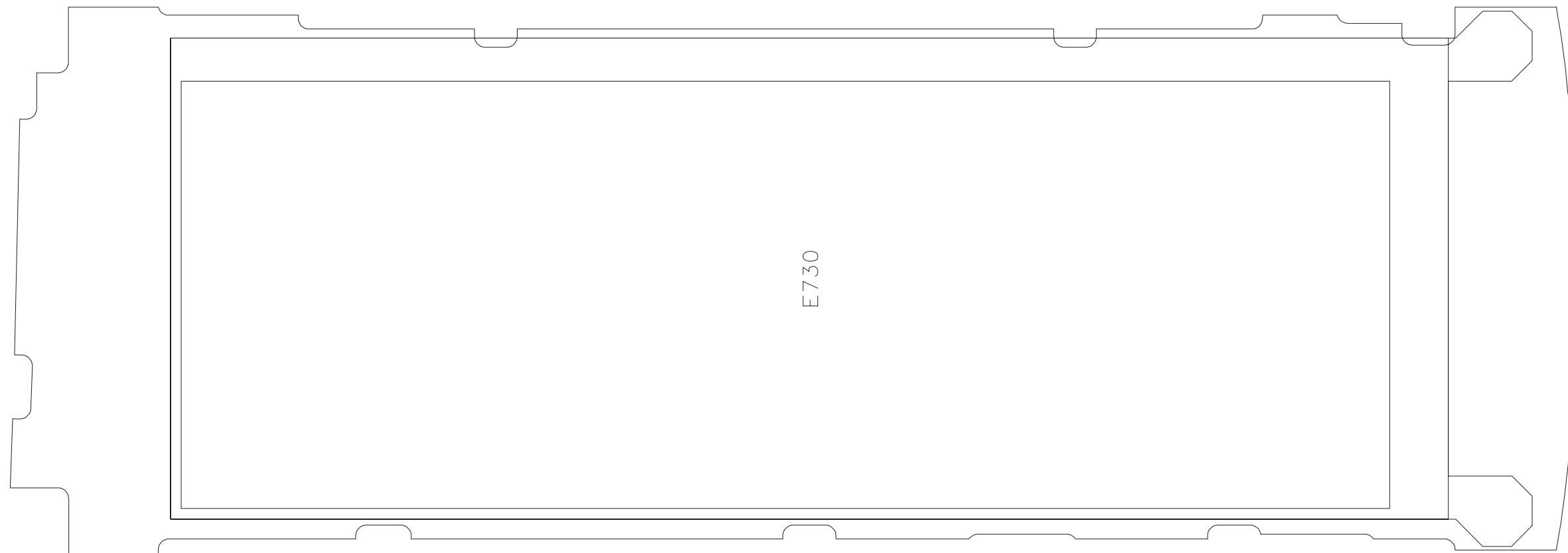

Block Diagram of BS8 (3.0 edit 57) v _09

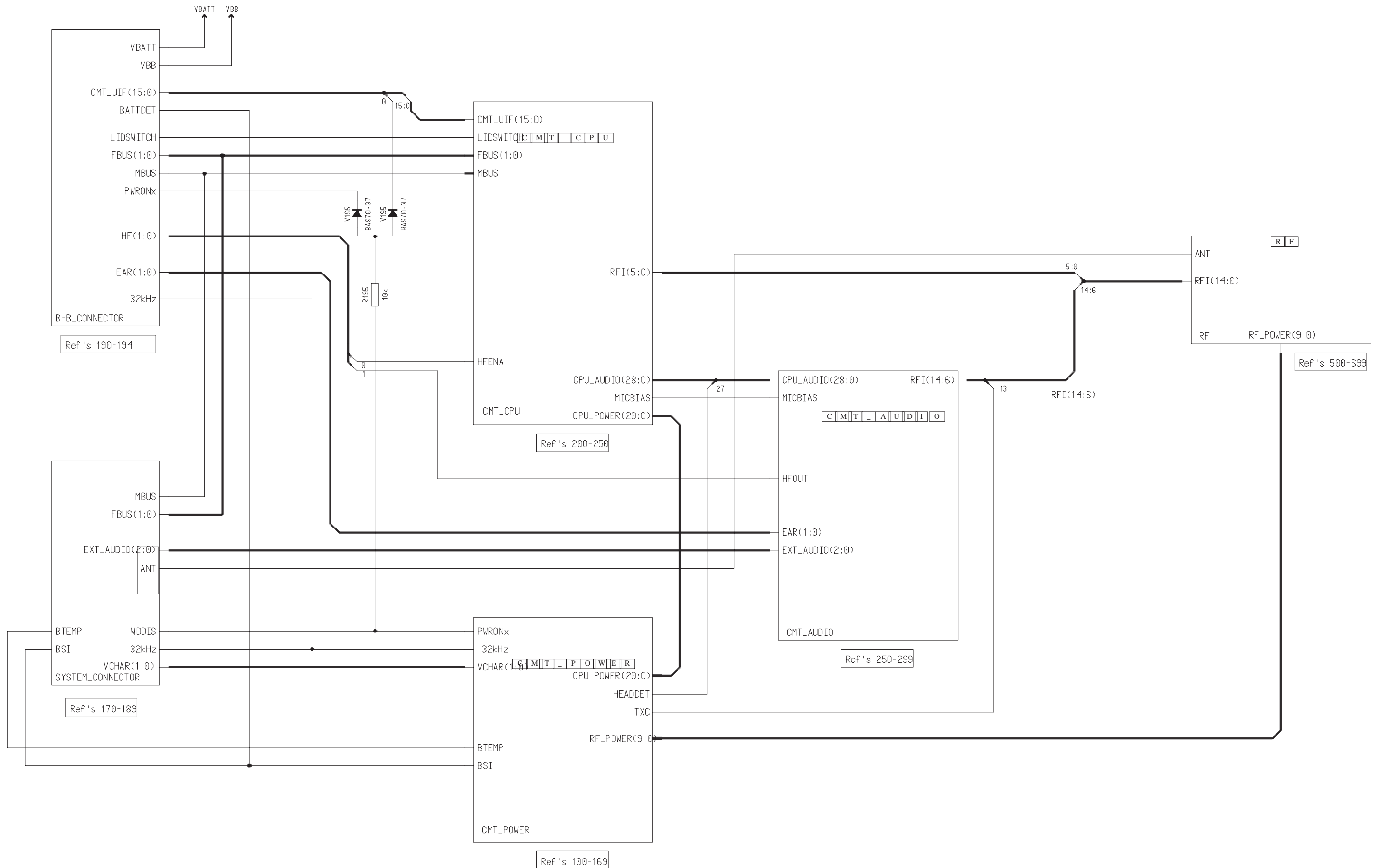

Circuit Diagram of BS8 GSM RF (2.0 Edit 104) _09

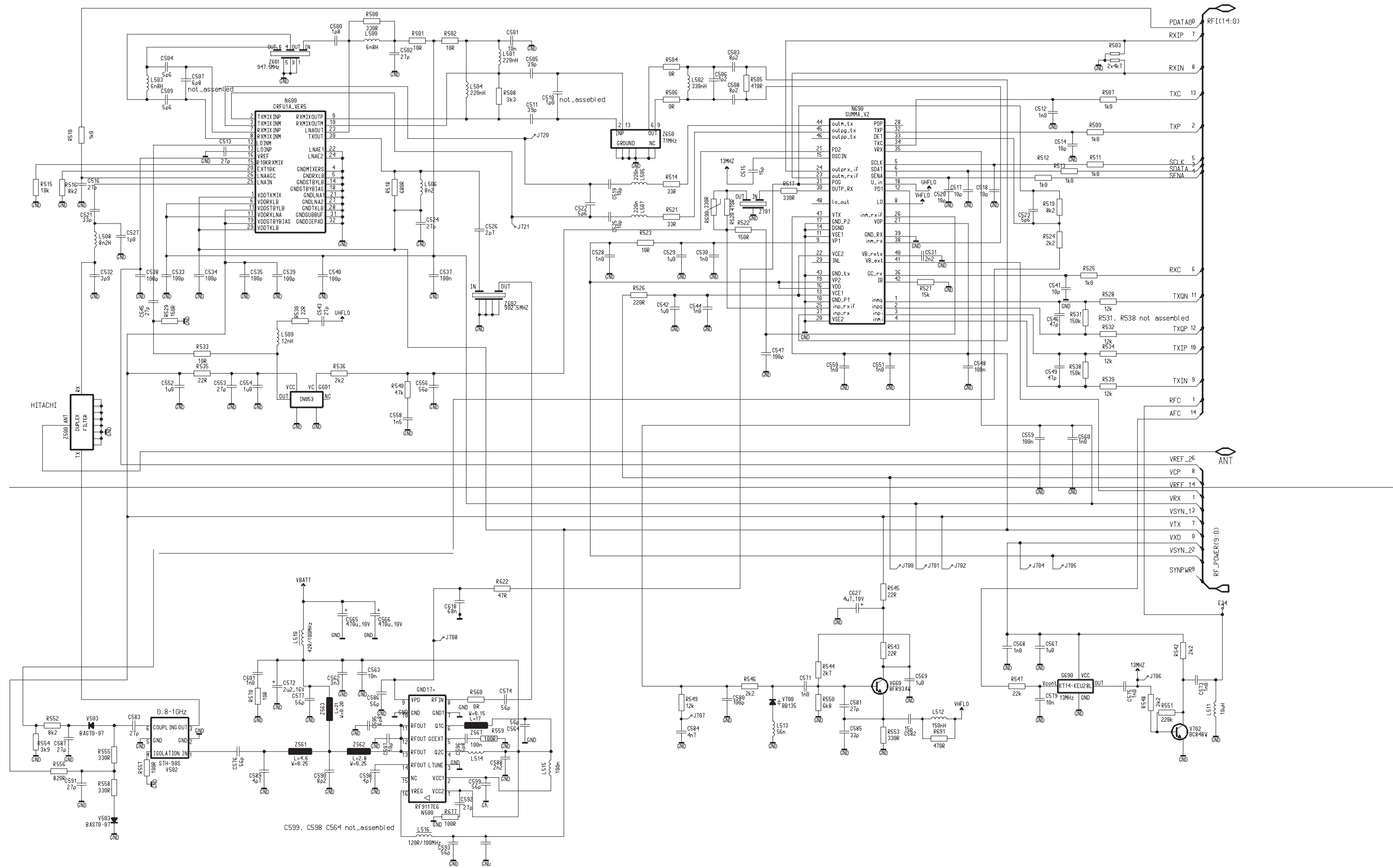

Circuit Diagram of BS8 CMT Power (3.1 Edit 111) _09

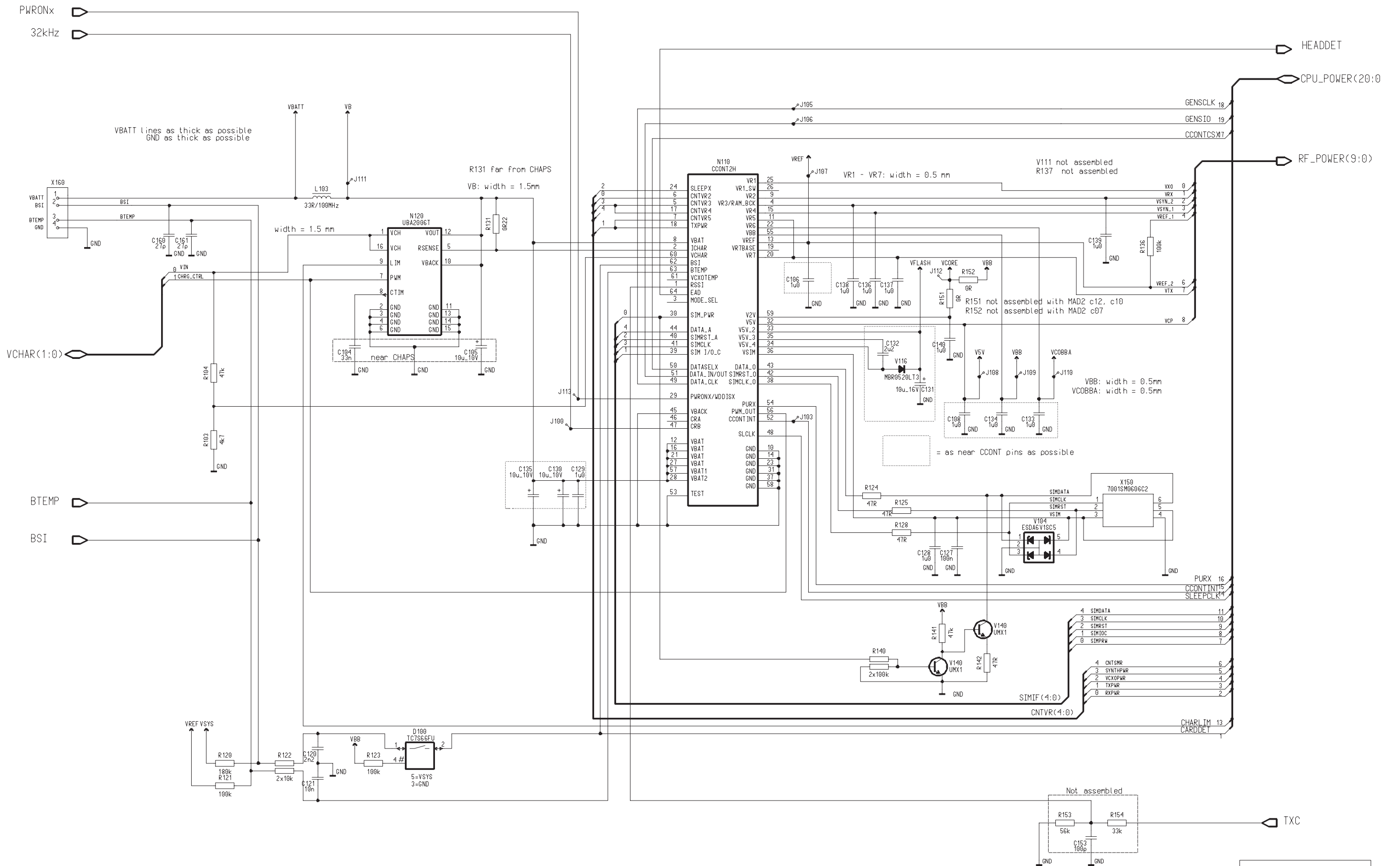

Circuit Diagram of BS8 System Connector (3.1 Edit 61) _09

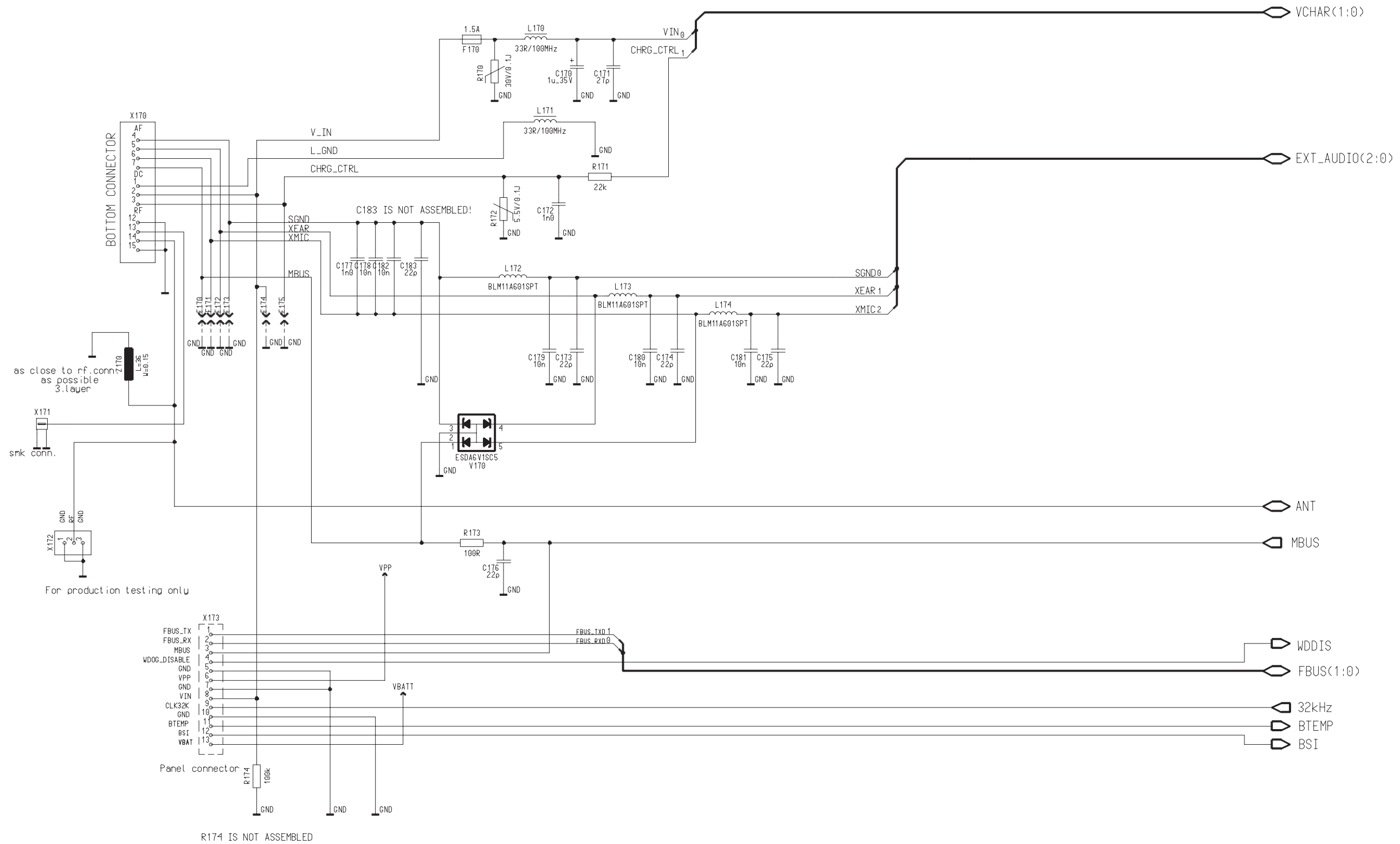

Circuit Diagram of BS8 Baseband Connector (3.1 Edit 50) _09

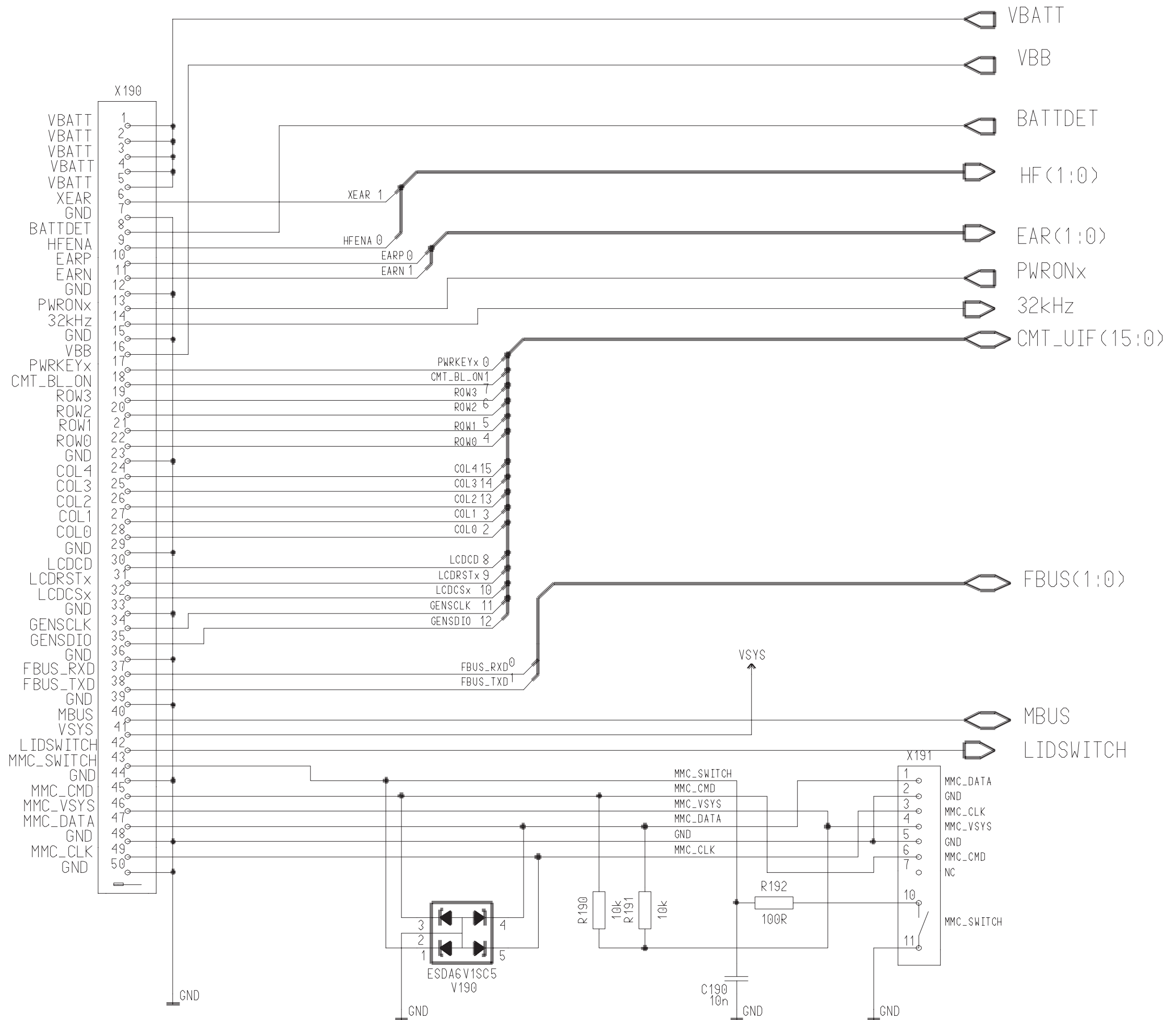

C190 and R192 are not assembled

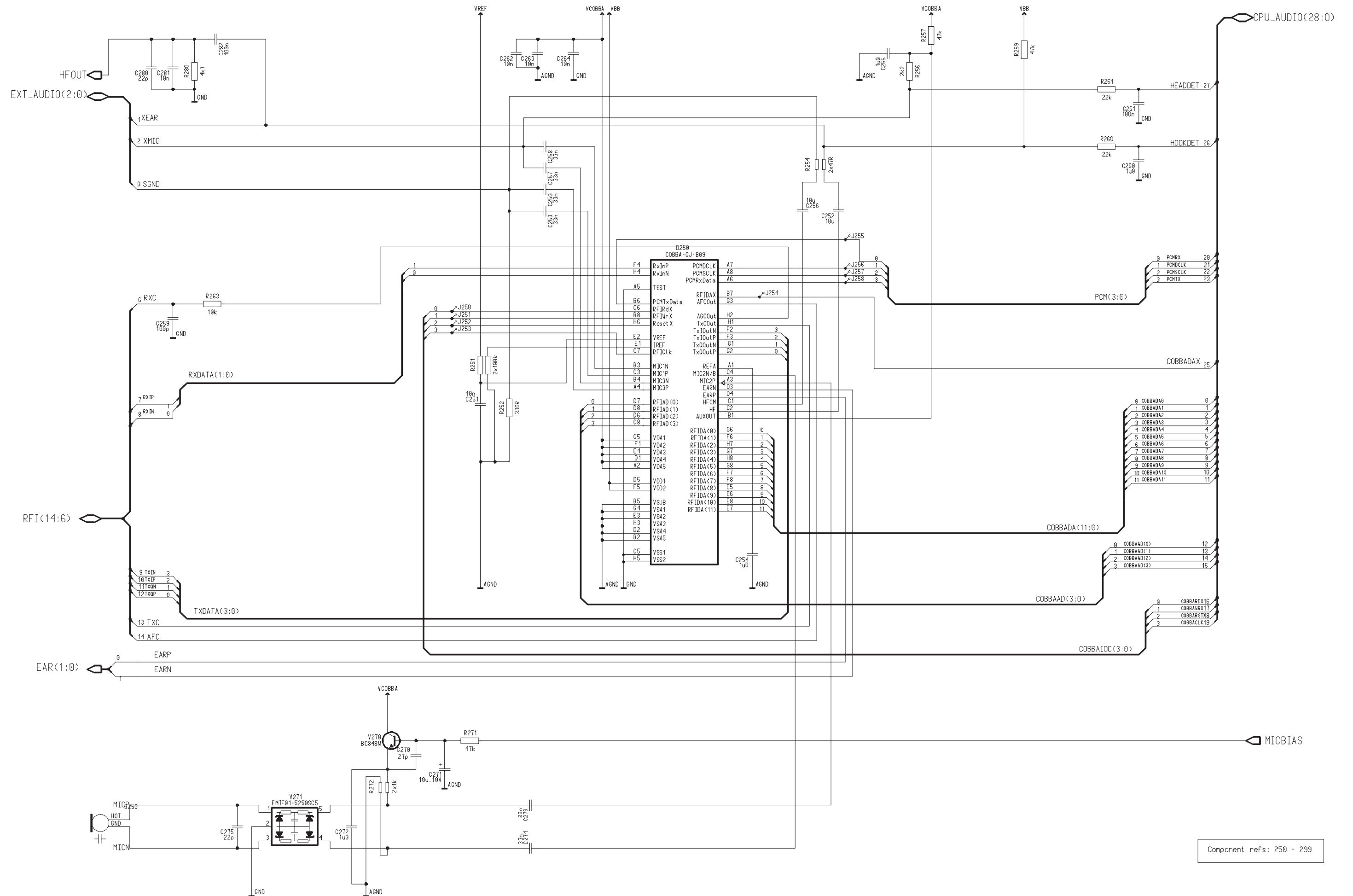

Component refs: 250 - 299

Parts Placement Diagram of BS2 _09

